

MACHINE DETECTOR INTERFACE ALIGNMENT UPDATE

Léonard WATRELOT

PhD student, CERN BE-GM-HPA section, SMI, CNAM (Conservatoire National des Arts et Métiers)

Mark JONES (CERN) and Stéphane DURAND (GeF, CNAM)

Many thanks to :

Manuela Boscolo, Francesco Franesini, Michael Koratzinos, Hélène Mainaud Durand, Mika Masuzawa, Luigi Pellegrino, Mateusz Sosin, Vivien Rude

FCC-ee MDI requirements so far

“The distance between the two calorimeters has to be measured to 110 μm ”

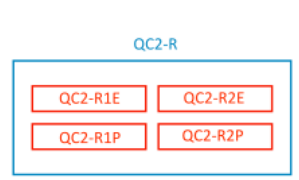
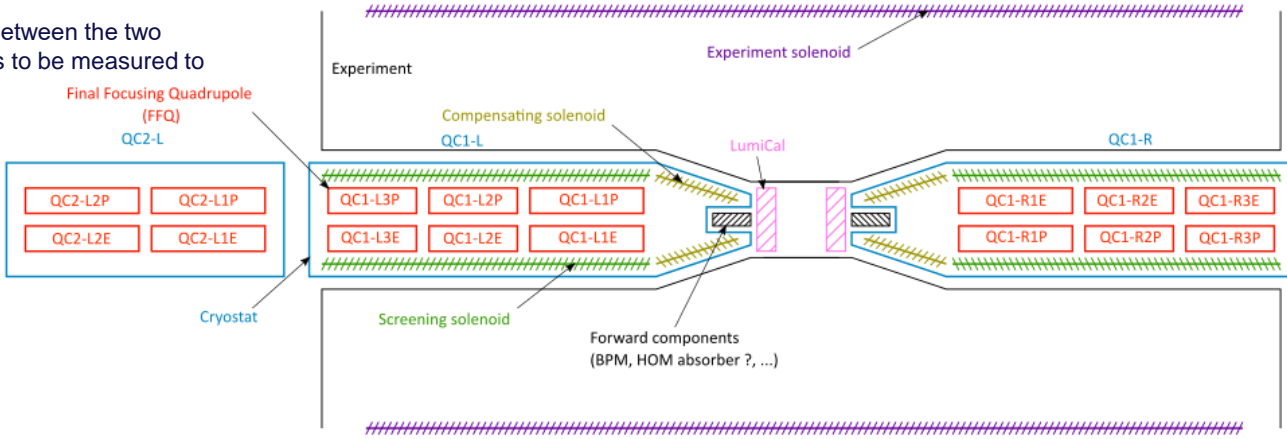

“Distance LumiCal/ nominal IP to be controlled/ measured to $\sim 50\mu\text{m}$ level”

“Final Focusing quads misalignment (QC1_1-QC1_3 and QC2_1-QC2_2) (if not respected, beams do not collide):

- Geodesy : transverse shift of FF quads with $\sigma_{xy} = 25\mu\text{m}$
- vibrations : transverse shift of FF quads with $\sigma_{xy} = 0.1\mu\text{m}$

IR BPM misalignment (if not respected, beams do not collide) :

- geodesy : transverse shift of BPM with $\sigma_{xy} = 25\mu\text{m}$
- vibrations : errors of BPM reading with $\sigma_{xy} = 0.1\mu\text{m}$

“Internal misalignment should be better than $30\mu\text{m}$ ”

“Measurement of the component's position inside the detector is needed”

“IR quadrupoles and sextupoles ($75\mu\text{m}$ in radial and longitudinal, $100\mu\text{rad}$ roll), BPM ($40\mu\text{m}$ in radial and $100\mu\text{rad}$ for the roll relative to quadrupole placement).”

“For a 1mrad tilt of the detector solenoid (wrt the rest of the system – beam, screening and compensation solenoid) the corresponding uncorrected distortion is unacceptably large.”

“Alignment accuracy of SC magnets = $100\mu\text{m}$ ”

Alignment strategies

Simple alignment

- Alignment during assembly
- Fiducialisation

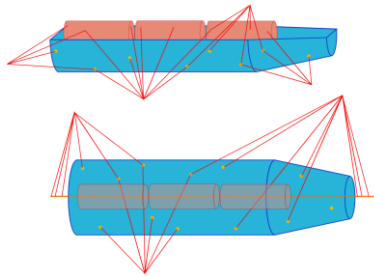

- Closing of the cryostat
- Installation in the experiment
thanks to the fiducialisation

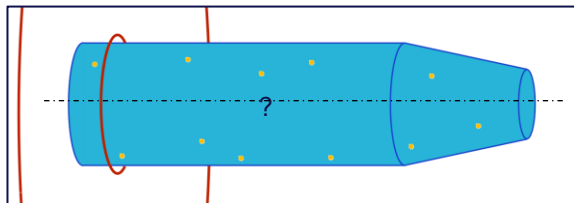

Installation and alignment of the cryostat
inside the experiment

Alignment strategies

Simple alignment

- Alignment during assembly
- Fiducialisation

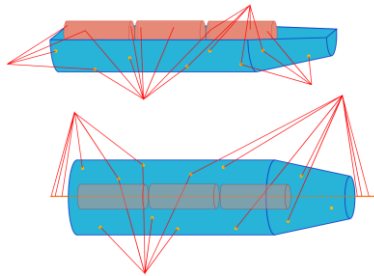

- Closing of the cryostat
- Installation in the experiment thanks to the fiducialisation

Alignment + monitoring

- Alignment during assembly + *installation of the monitoring system*
- Fiducialisation
- Closing of the cryostat
- *Checking of the alignment during transport, tests and installation*
- Installation in the experiment thanks to the fiducialisation *and the monitoring system*
- *Monitoring*

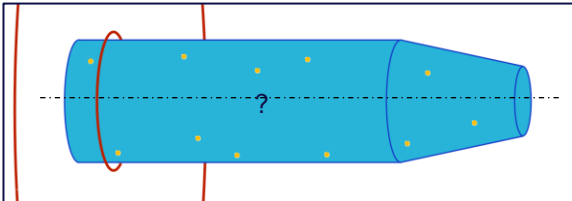

Installation and alignment of the cryostat inside the experiment

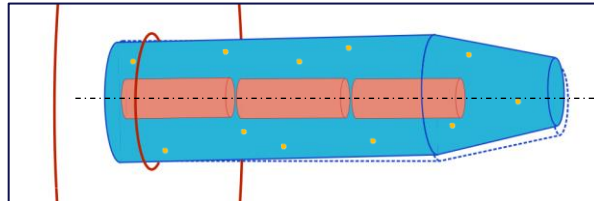

Installation of the misaligned cryostat inside the experiment so the FFQ are aligned

Alignment strategies

Simple alignment

- Alignment during assembly
- Fiducialisation

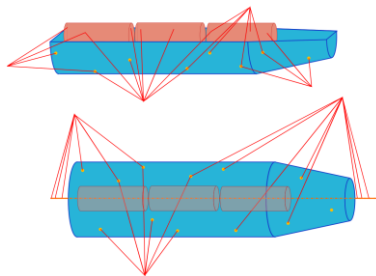

- Closing of the cryostat
- Installation in the experiment thanks to the fiducialisation

Alignment + monitoring

- Alignment during assembly + *installation of the monitoring system*
- Fiducialisation
- Closing of the cryostat
- *Checking of the alignment during transport, tests and installation*
- Installation in the experiment thanks to the fiducialisation *and the monitoring system*
- *Monitoring*

Pre-alignment + monitoring + re-adjustment

- Alignment during assembly + *installation of the monitoring system + re-adjustment system*
- Fiducialisation
- Closing of the cryostat
- *Checking of the alignment during transport, tests and installation*
- Installation in the experiment thanks to the fiducialisation *and the monitoring system + re-alignment*
- *Monitoring and realignment if needed thank to monitoring and re-adjustment systems*

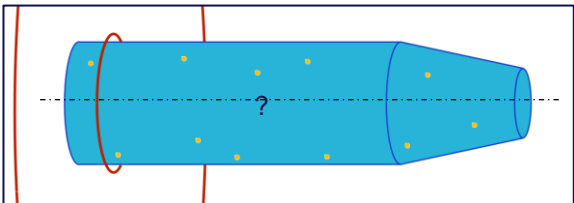

Installation and alignment of the cryostat inside the experiment

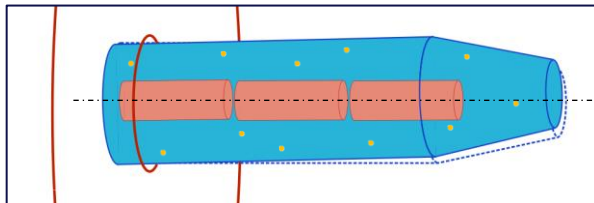

Installation of the misaligned cryostat inside the experiment so the FFQ are aligned

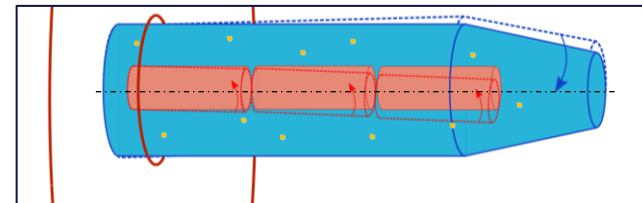

Installation and readjustment of the components so everything is correctly aligned

Alignment strategies

Simple alignment

Until recently, was the main technique used.

- Cheap
- Relatively easy
- no information on the true state and position of the inner components
- Requires a desinstallation and reopening of the cryostat if the misalignment is too important

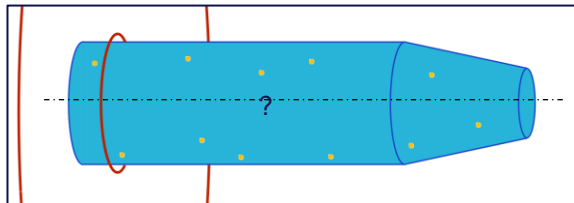

Installation and alignment of the cryostat inside the experiment

Alignment strategies

Simple alignment

Until recently, was the main technique used.

- Cheap
- Relatively easy

- no information on the true state and position of the inner components
- Requires a desinstallation and reopening of the cryostat if the misalignment is too important

Alignment + monitoring

Better solution, aim of current and future projects (HL-LHC, CLIC, ILC, CEPC, FCC).

- Continuous monitoring of the inner components from assembly to the run of the machine
- Installation thanks to the monitoring data : wanted "Misaligned" installation to align with respect to the inner components and not the cryostat

- Complex installation
- More expensive
- Requires space inside the cryostat

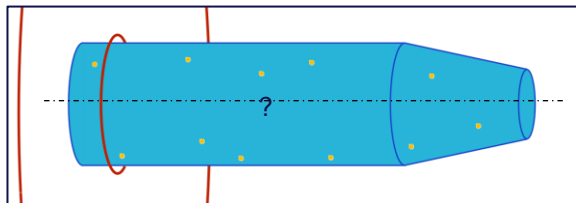

Installation and alignment of the cryostat inside the experiment

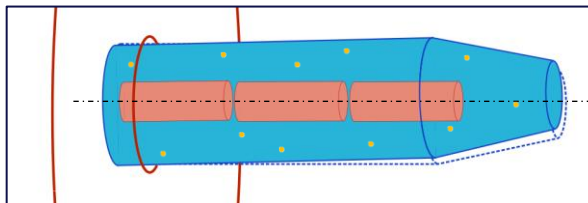

Installation of the misaligned cryostat inside the experiment so the FFQ are aligned

Alignment strategies

Simple alignment

Until recently, was the main technique used.

- Cheap
- Relatively easy
- no information on the true state and position of the inner components
- Requires a desinstallation and reopening of the cryostat if the misalignment is too important

Alignment + monitoring

Better solution, aim of current and future projects (HL-LHC, CLIC, ILC, CEPC, FCC).

- Continuous monitoring of the inner components from assembly to the run of the machine
- Installation thanks to the monitoring data : wanted "Misaligned" installation to align with respect to the inner components and not the cryostat
- Complex installation
- More expensive
- Requires space inside the cryostat

Pre-alignment + monitoring + re-adjustment

Optimal solution.

- Continuous monitoring of the inner components from assembly to the run of the machine
- Re-adjustment thank to the sensor measurements
- Complex installation and operation
- More expensive
- May require more space inside the cryostat
- Lot of R&D required

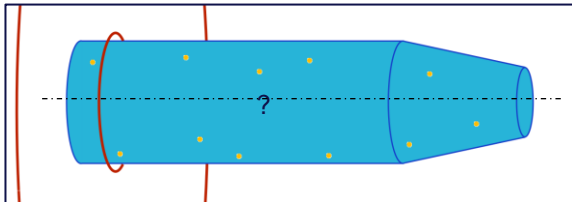

Installation and alignment of the cryostat inside the experiment

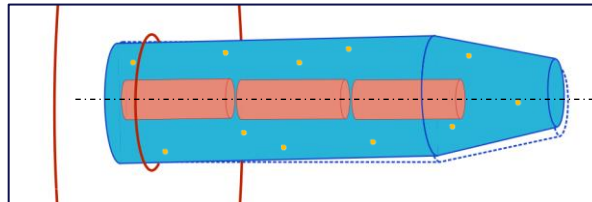

Installation of the misaligned cryostat inside the experiment so the FFQ are aligned

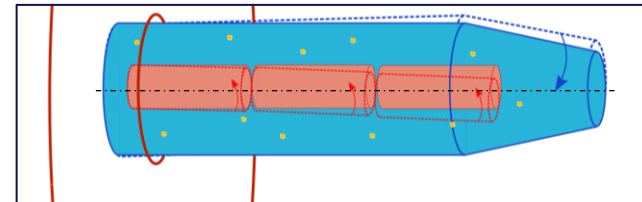

Installation and readjustment of the components so everything is correctly aligned

Alignment strategies

monitoring

Real time	Each technical stops	At the end of the LS
Every components	The most important components	Few strategic components
3 translations and 3 rotations	Some movements	One or two movements

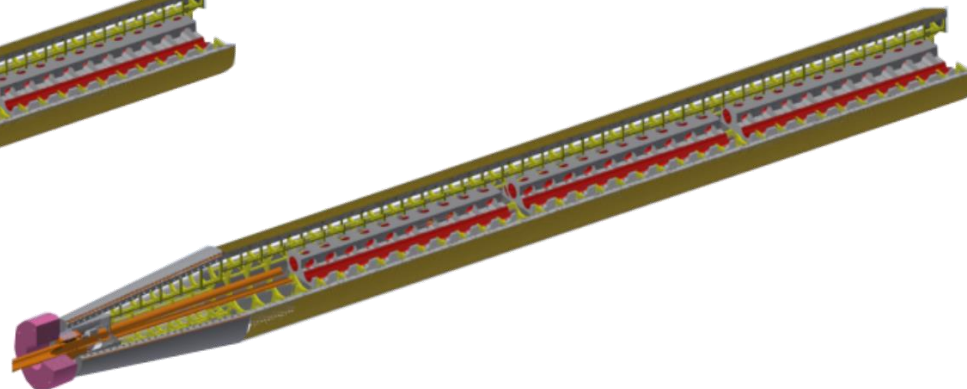
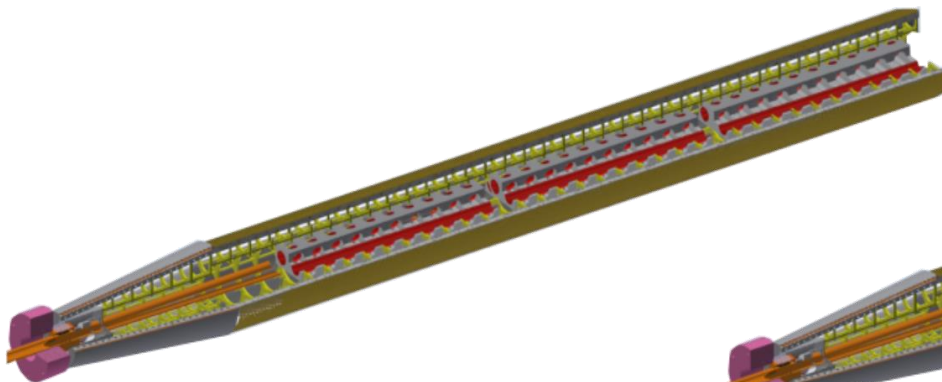

Real time	Each technical stops	At the end of the LS
Every components	The most important components	Few strategic components
3 translations and 3 rotations	Some movements	One or two movements

re-adjustment

Alignment strategies

monitoring

Real time	Each technical stops	At the end of the LS
Every components	The most important components	Few strategic components
3 translations and 3 rotations	Some movements	One or two movements

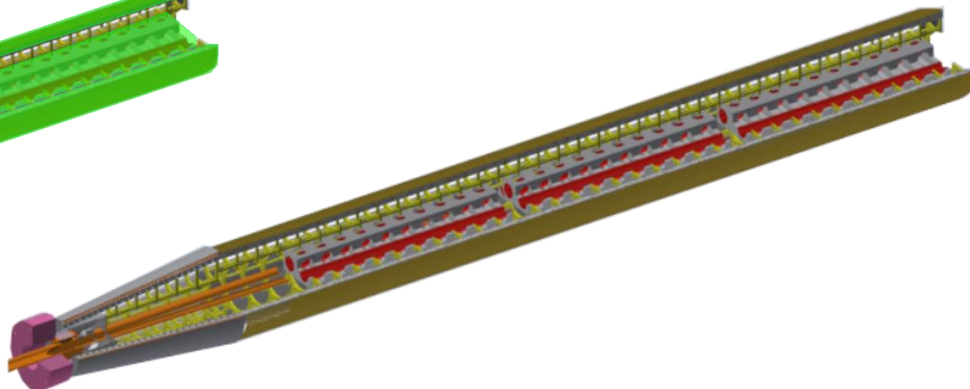
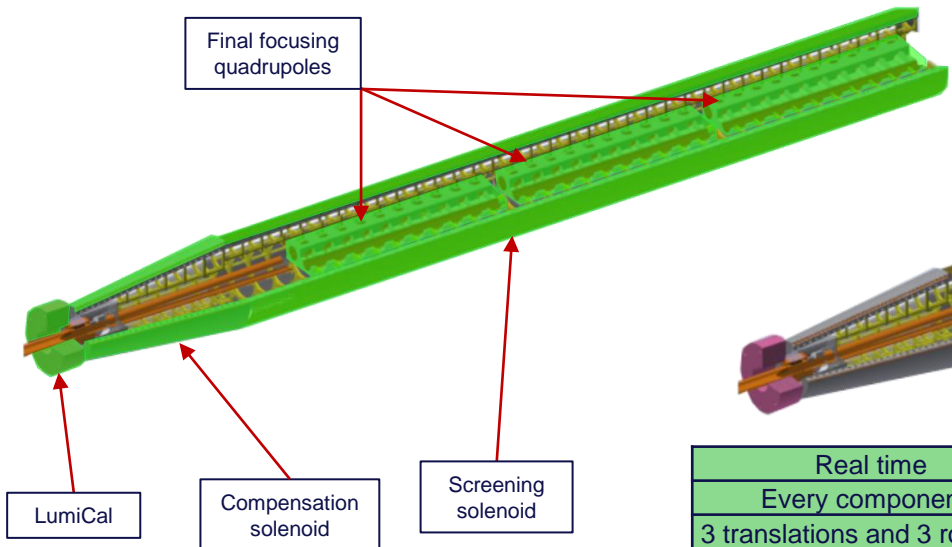

Real time	Each technical stops	At the end of the LS
Every components	The most important components	Few strategic components
3 translations and 3 rotations	Some movements	One or two movements

re-adjustment

Alignment strategies

monitoring

Real time	Each technical stops	At the end of the LS
Every components	The most important components	Few strategic components
3 translations and 3 rotations	Some movements	One or two movements

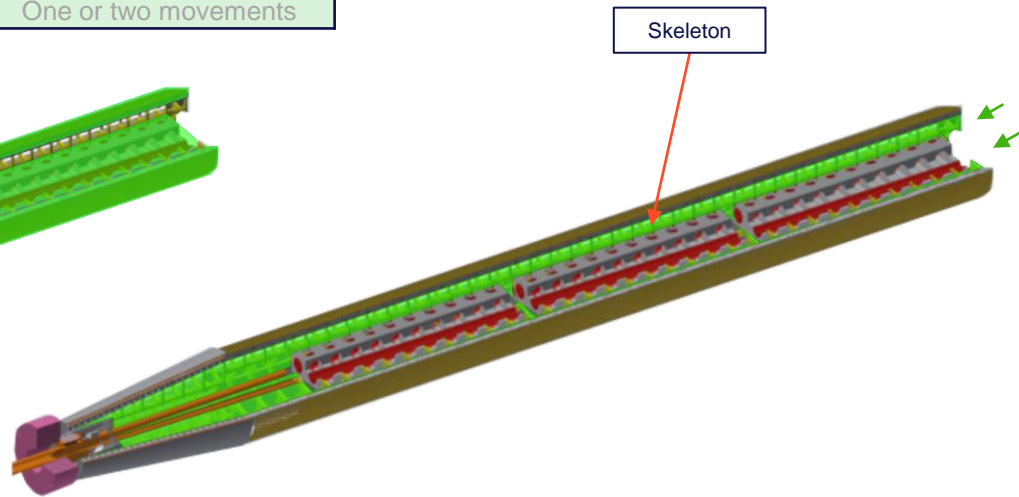
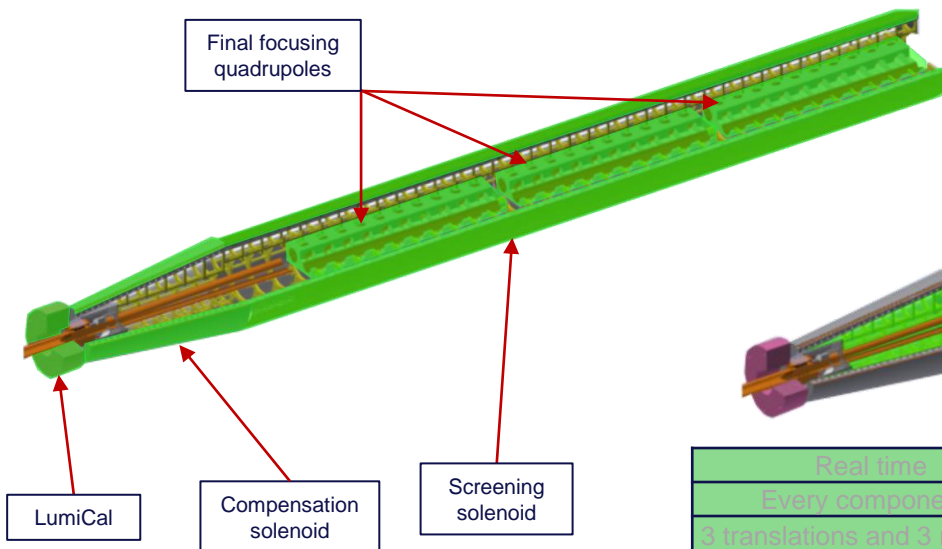

Real time	Each technical stops	At the end of the LS
Every components	The most important components	Few strategic components
3 translations and 3 rotations	Some movements	One or two movements

re-adjustment



Strategy for the new system

Strategy for a new system

Two systems to monitor the MDI:

- external monitoring system
- Internal monitoring system

The interface will be monitored from the outside of the experiment. The network will determine the translations and rotations (and scale factor if required) of the interface. Doing that will allow the alignment of the interfaces of the two sides of the detector.

The interface will serve as an origin to compute the deformations of the cryostat and/or skeleton and the position of the inner elements.

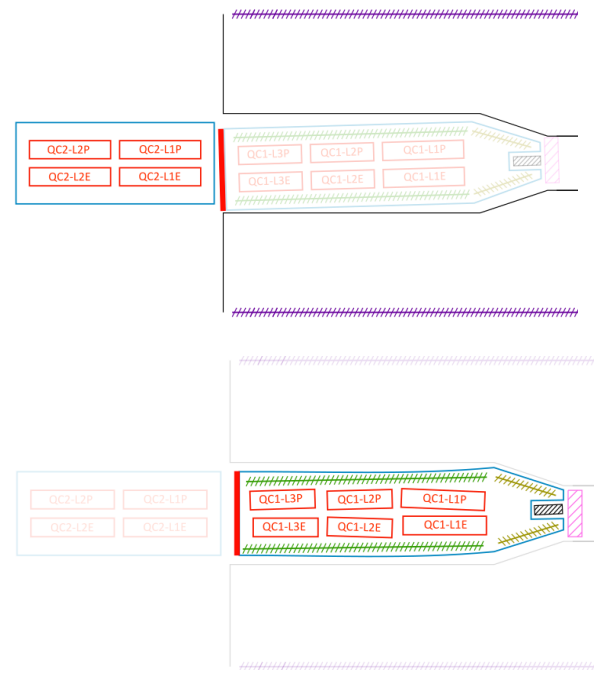
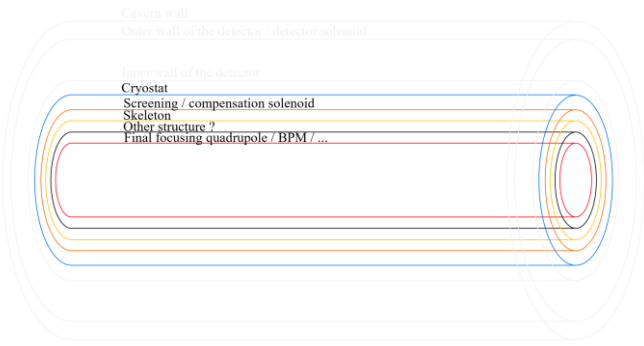
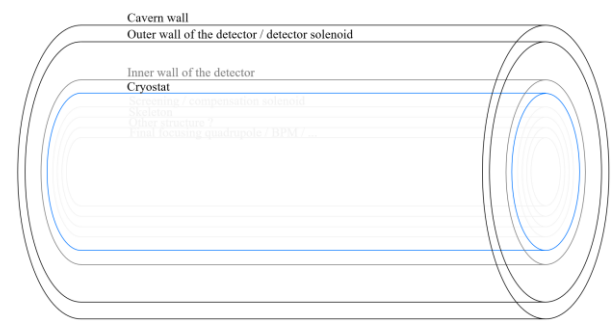
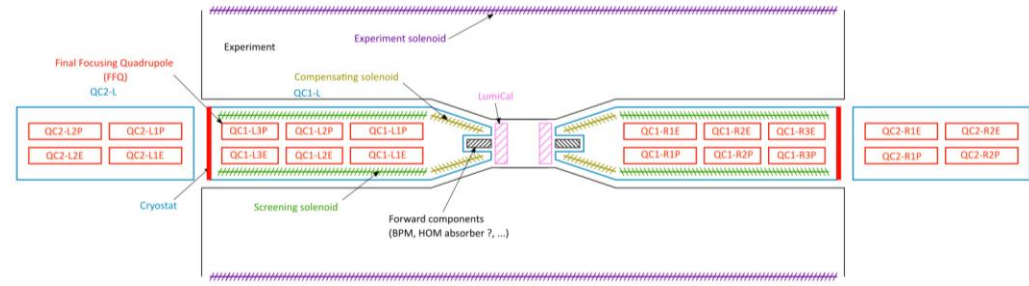

External monitoring system

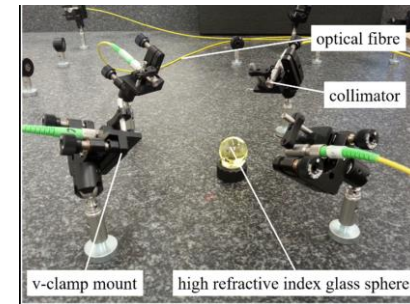
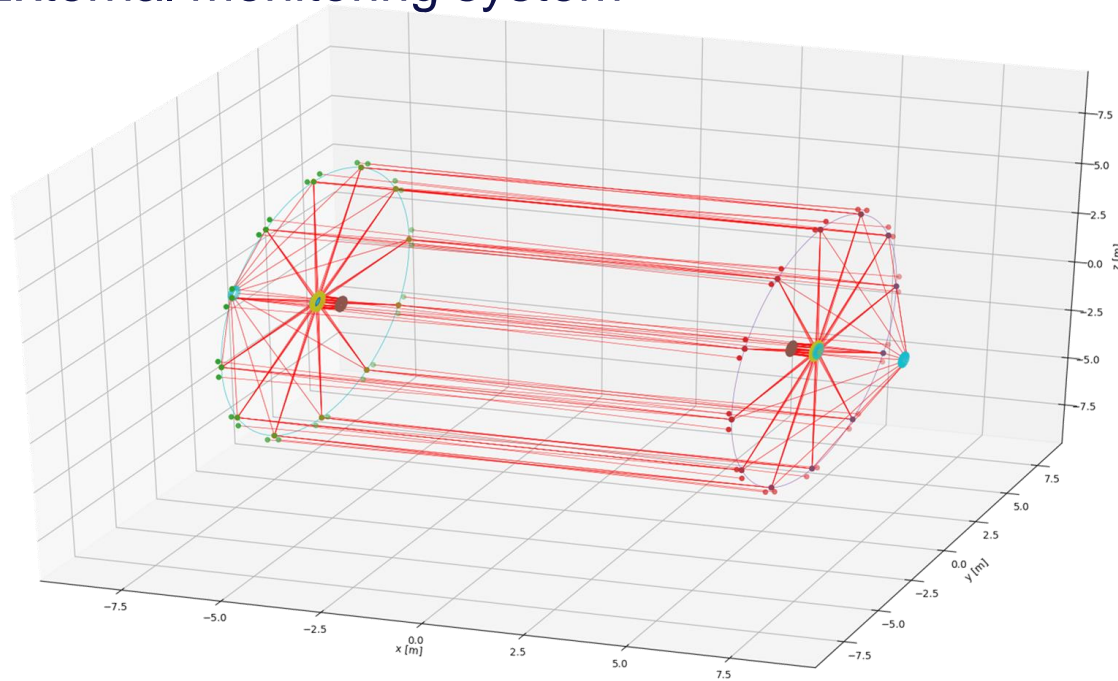

Gayde, J-Ch, and Kamugasa, S., "Evaluation of Frequency Scanning Interferometer Performances for Surveying, Alignment and Monitoring of Physics Instrumentation." (2018): WEPAF069.

Network of laser distance measurements (multi-target FSI)

External monitoring system

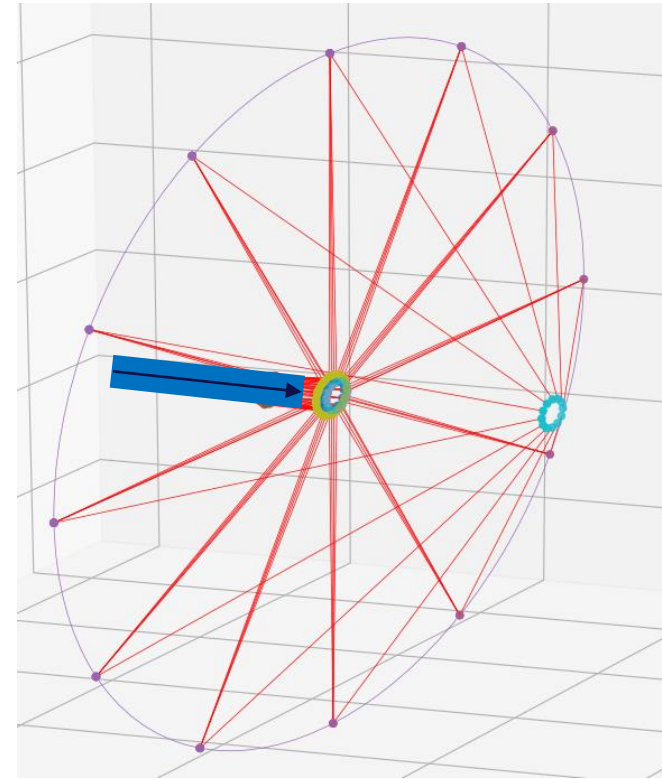
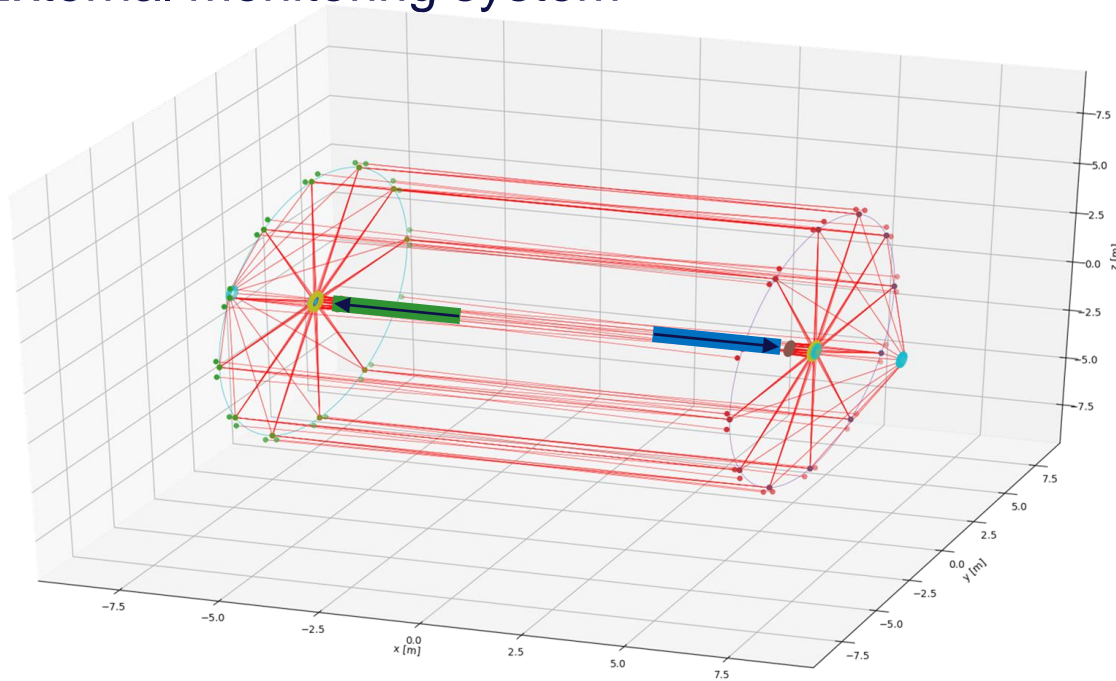

Goals :

Monitor the end of QC1 to have the position of internal components (monitored thanks to the internal monitoring system).

External monitoring system

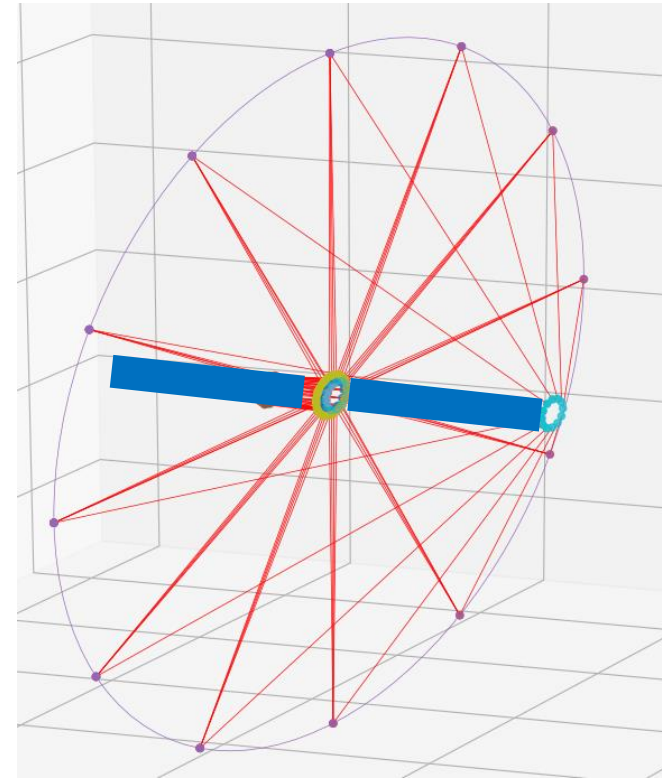
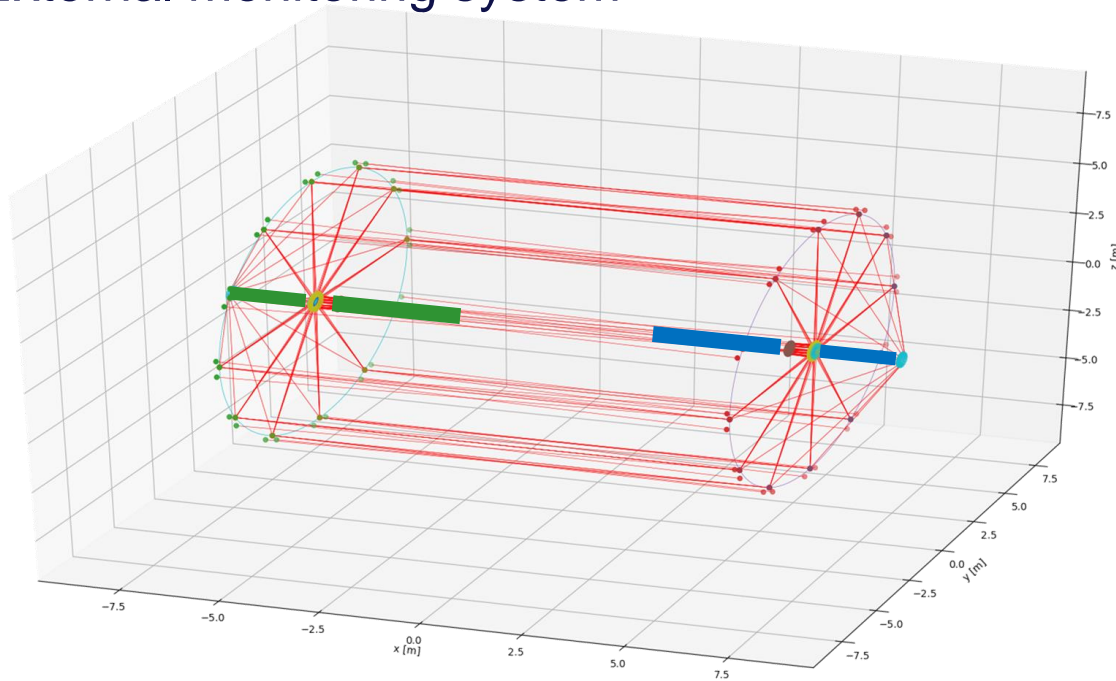

Goals :

- Monitor the end of QC1 to retrieve the position of internal component (monitored thanks to the internal monitoring system).
- Monitor the alignment between QC1 and QC2.

External monitoring system

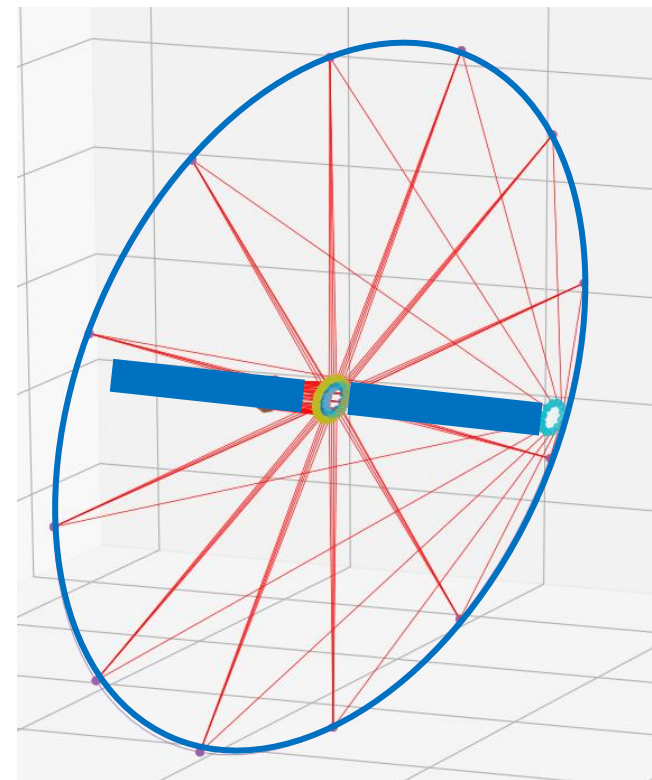
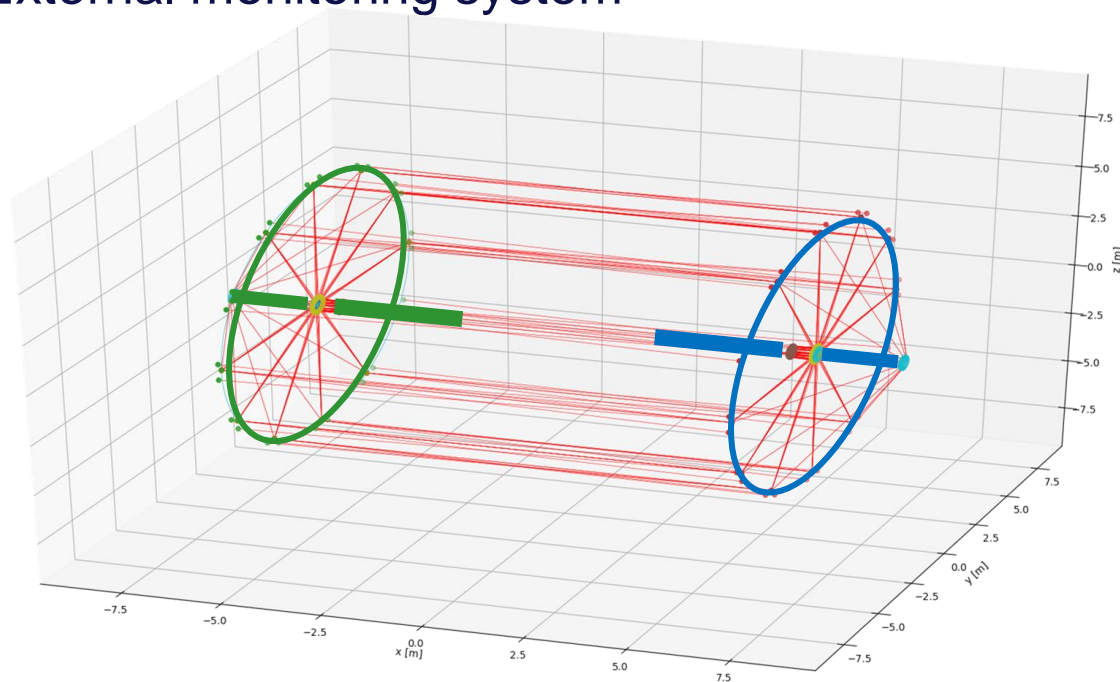

Goals :

- Monitor the end of QC1 to retrieve the position of internal component (monitored thanks to the internal monitoring system).
- Monitor the alignment between QC1 and QC2.
- Monitor the alignment between the inner components and the experiment solenoid.

External monitoring system

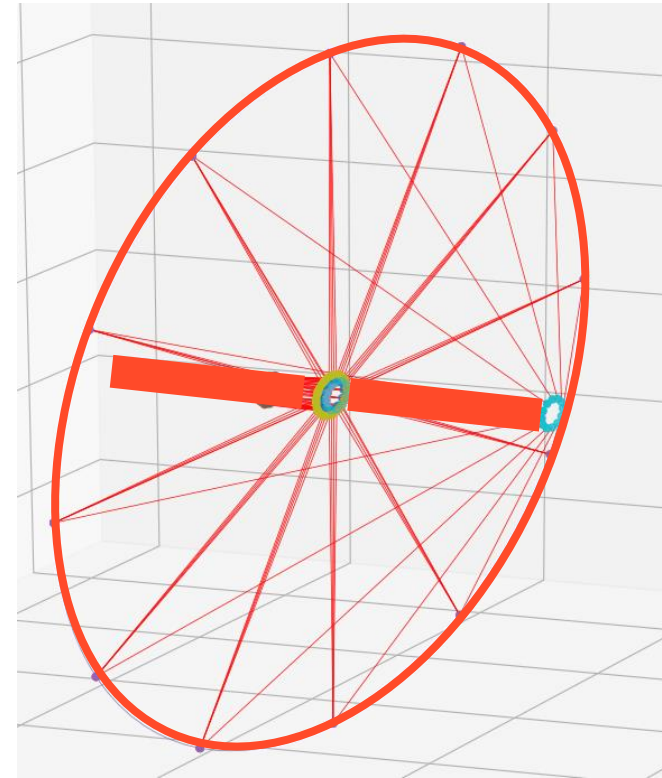
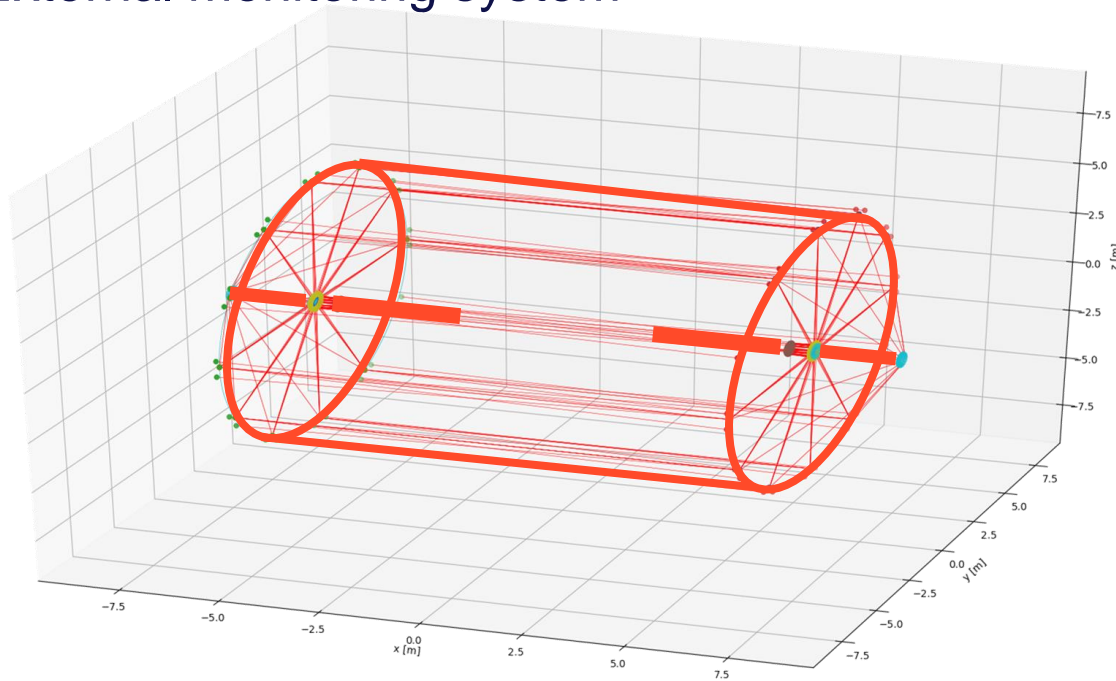

Goals :

Monitor the end of QC1 to retrieve the position of internal component (monitored thanks to the internal monitoring system).

Monitor the alignment between QC1 and QC2.

Monitor the alignment between the inner components and the experiment solenoid.

Monitor the alignment between the two sides of the experiment.

CLD

QC1 partly inside
QC2 entirely outside

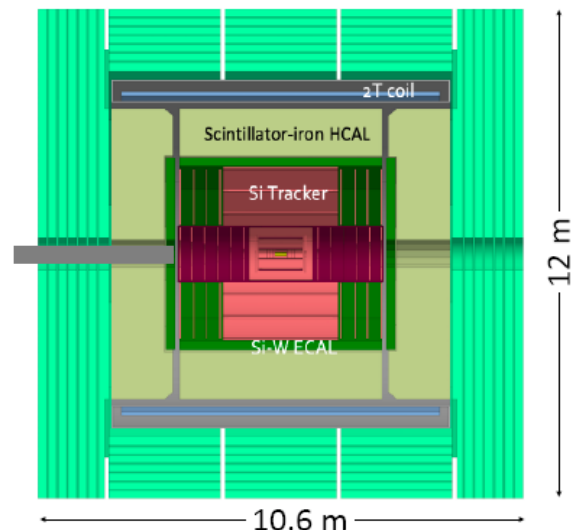
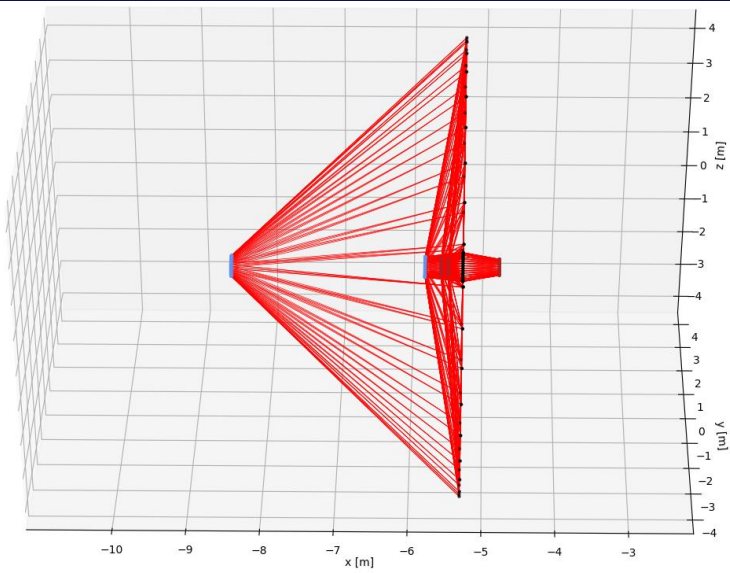

HOFFMAN, A. C., PÀRES, G., FRITZSCH, T., *et al.* Detector Technologies for CLIC. *arXiv preprint arXiv:1905.02520*, 2019.

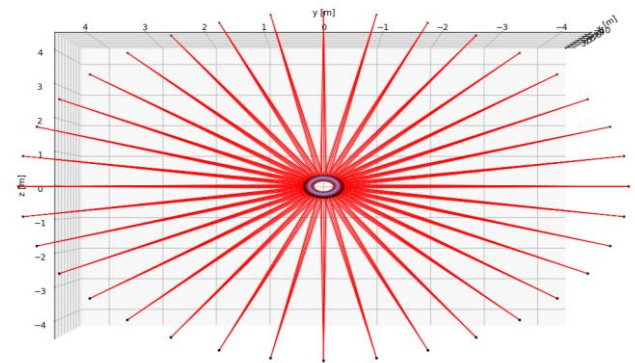
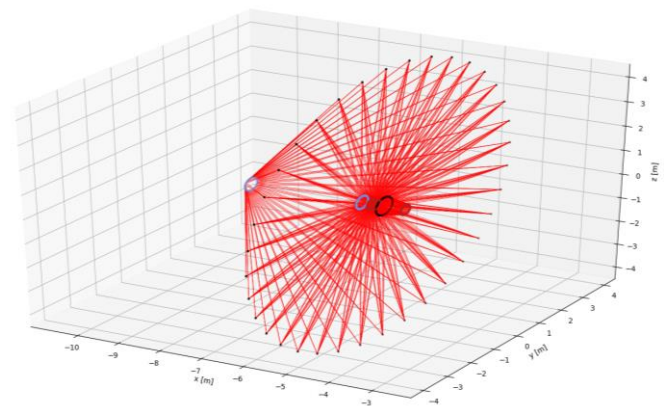

Optimal network : too much measurements, some (plenty) wont be possible.
Any update on the design would be much welcomed.

IDEA

QC1 entirely inside
QC2 partly inside

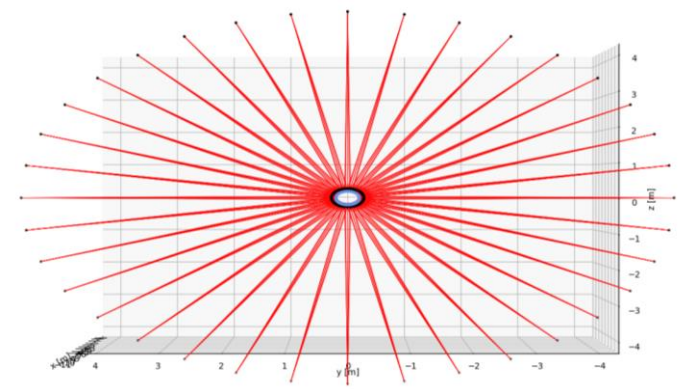
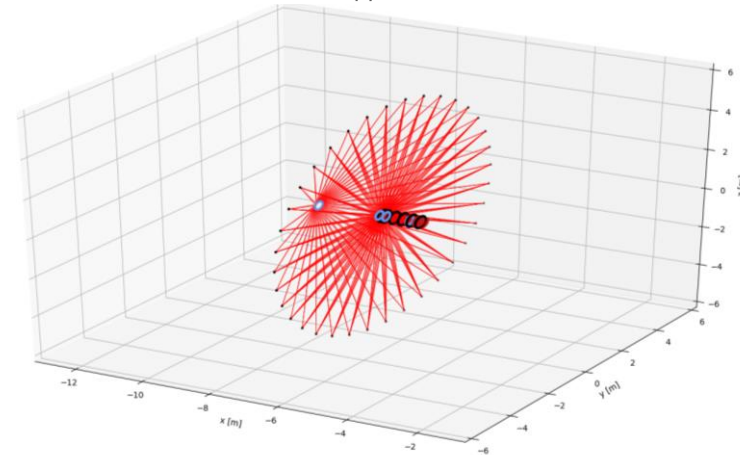
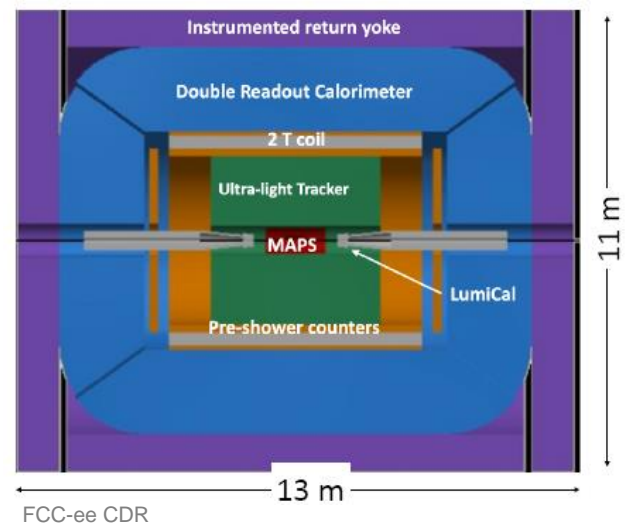
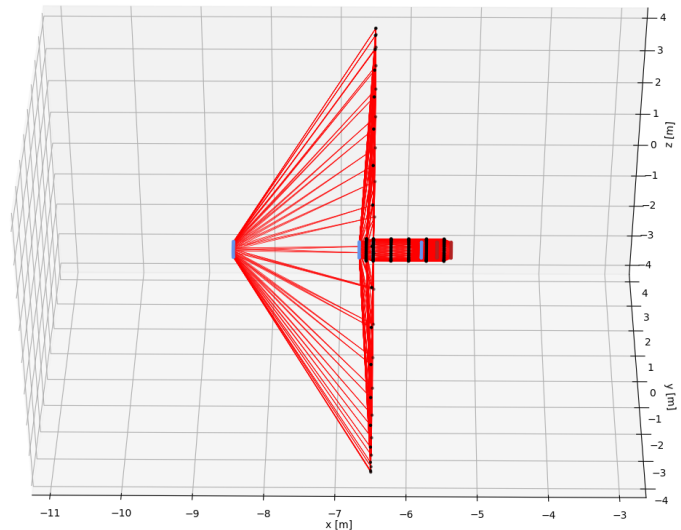

Optimal network : too much measurements, some (plenty) wont be possible.
Any update on the design would be much welcomed.

Internal monitoring system

- Critical part and heart of my work
- Currently no existing system capable of such precise measurements (~ 10 μm) in harsh conditions
- Simulations on new systems are ongoing and promising
- Any update on the design would be much welcomed

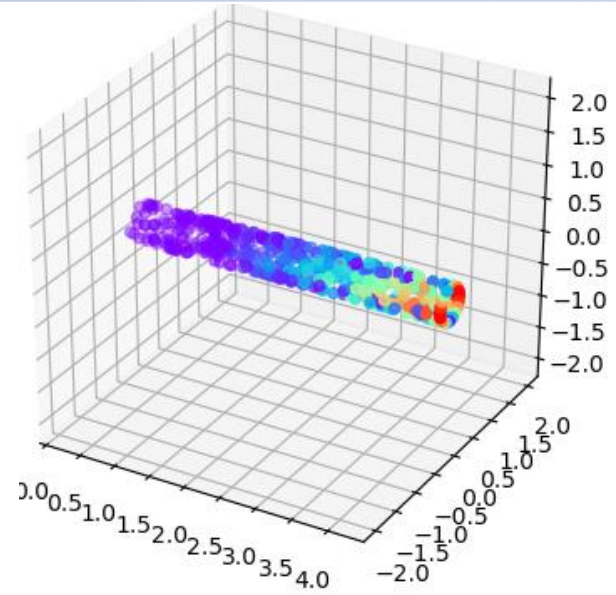
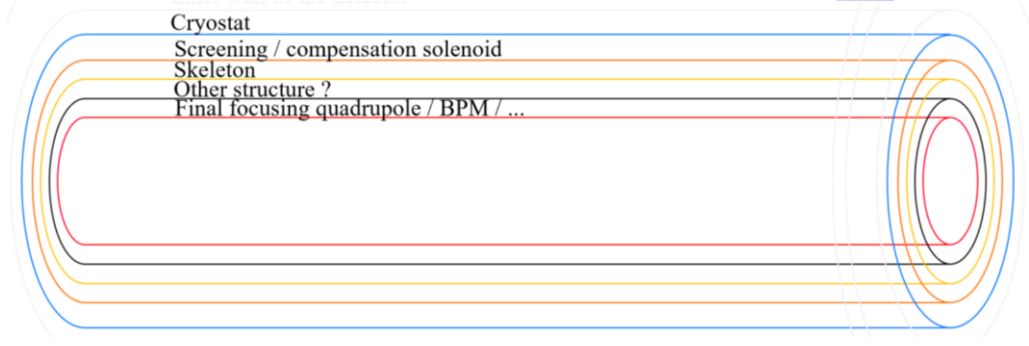
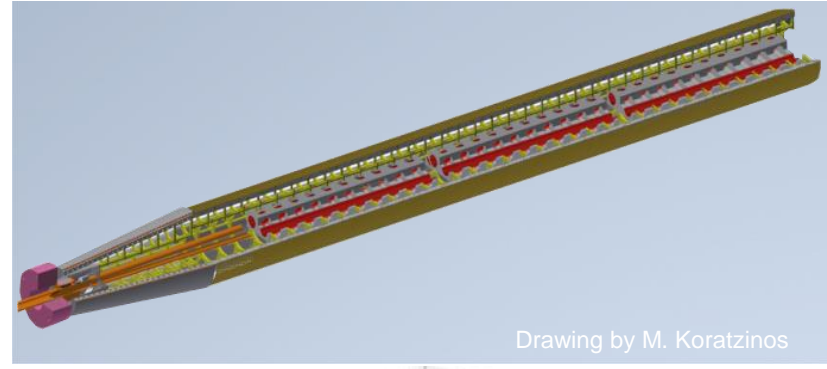

Deformation simulation

Interaction region alignment

FRAS, Full remote alignment system

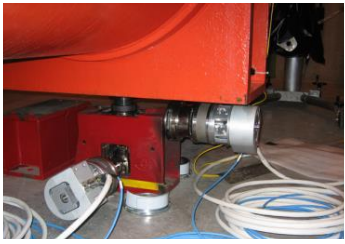

LHC / HL-LHC full remote alignment system for the Low-β quadrupoles

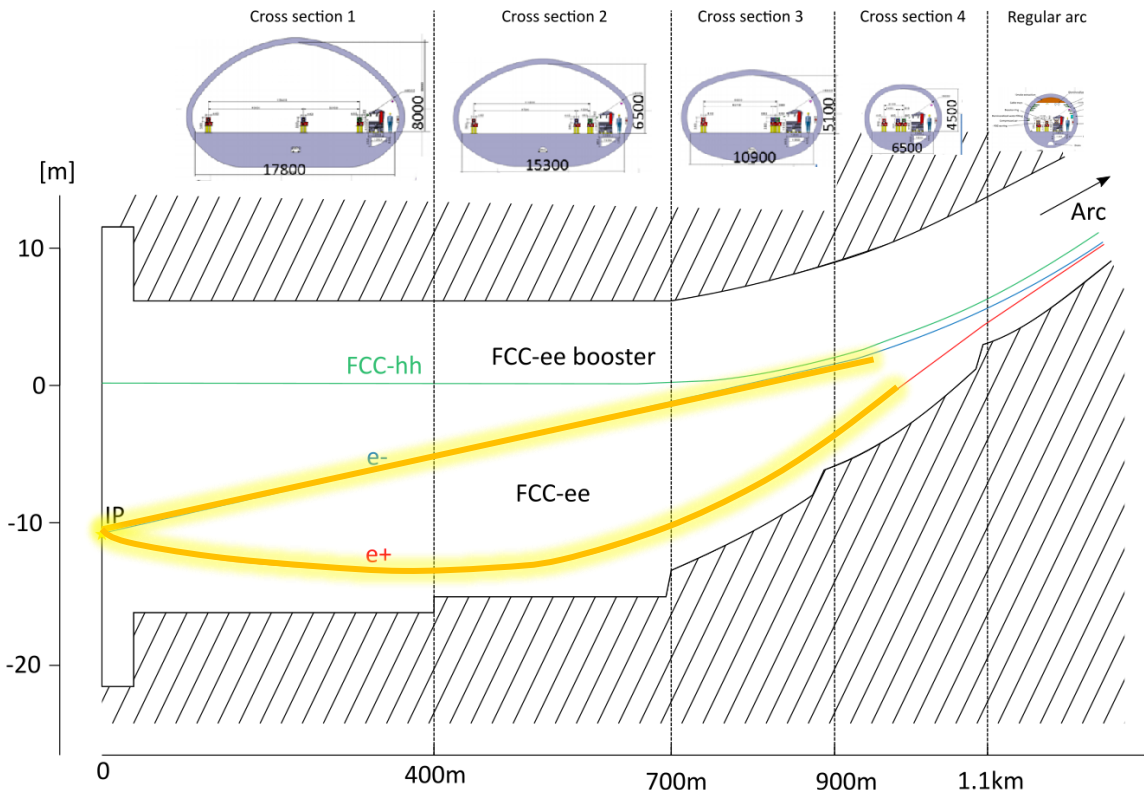

RMS misalignment and field errors tolerances:

Type	ΔX (μm)	ΔY (μm)	ΔPSI (μrad)	ΔS (μm)	$\Delta THETA$ (μrad)	ΔPHI (μrad)
Arc quadrupole*	50	50	300	150	100	100
Arc sextupoles*	50	50	300	150	100	100
Dipoles	1000	1000	300	1000	-	-
Girders	150	150	-	1000	-	-
IR quadrupole	100	100	250	50	100	100
IR sextupoles	100	100	250	50	100	100
BPM**	-	-	100	-	-	-

* misalignment relative to girder placement
 ** misalignment relative to quadrupole placement

Optics correction, Tessa Charles, FCCIS
 29/11/2021



Thank you
for your attention

- “Internal misalignment should be better than $30\mu\text{m}$ ”,
M. Koratzinos, "CCTFF quad design status", MDI workshop, 30/01/2018
- “Final Focusing quads misalignment (QC1_1-QC1_3 and QC2_1-QC2_2) (if not respected, beams do not collide):
 - o Geodesy : transverse shift of FF quads with $\sigma_{xy} = 25\mu\text{m}$
 - o vibrations : transverse shift of FF quads with $\sigma_{xy} = 0.1\mu\text{m}$
- IR BPM misalignment (if not respected, beams do not collide) :
 - o geodesy : transverse shift of BPM with $\sigma_{xy} = 25\mu\text{m}$
 - o vibrations : errors of BPM reading with $\sigma_{xy} = 0.1\mu\text{m}$
- The beam parameters are destroyed after correction of $25\mu\text{m}$ IR BPM misalignments
S.Sinyatkin, "Orbit errors at the FCC-ee due to the FF quadrupoles displacements"
- "Measurement of the component's position inside the detector is needed",
A. Bogomyagkov, A. Krasnov, E. Levichev, S. Pivovarov, S. Sinyatkin, BINP, "Summary and comments on Machine Detector Interface", MDI workshop 09-20 september 2019
- "The distance between the two calorimeters has to be measured to $110\mu\text{m}$ ",
M. Boscolo, "Summary of the 2nd FCC-ee MDI workshop", Workshop on the mechanical optimization of the FCC-ee MDI, january 30 to february 9 2018, CERN
- “Internal to LumiCal : assembly and metrology/ alignment of Si readout pads to $\sim 1.5\mu\text{m}$ radial precision External to LumiCal : need very high precision : distance LumiCal/ nominal IP to be controlled/ measured to $\sim 50\mu\text{m}$ level”,
M. Boscolo, "FCC-ee MDI design as outcome of the first week of MDI workshop and goal of this week workshop", Workshop on the mechanical optimization of the FCC-ee MDI, January 30 - February 9 2018, CERN quoting Mogens Dam/ NBI Copenhagen
- “Alignment accuracy of SC magnets = $100\mu\text{m}$ ”
M. Boscolo, CEPC workshop MDI design highlight (24th MDI meeting)
- “For a 1mrad tilt of the detector solenoid (wrt the rest of the system – beam, screening and compensation solenoid) the corresponding uncorrected distortion is unacceptably large.”
Mike Koratzinos
- “IR quadrupoles and sextupoles ($75\mu\text{m}$ in radial and longitudinal, $100\mu\text{rad}$ roll), BPM ($40\mu\text{m}$ in radial and $100\mu\text{rad}$ for the roll relative to quadrupole placement).”
Summary of emittance tuning results, Tessa Charles, 20/10/2020